

Royde & Tucker H131-400 HI-LOAD pivot set - NFR Application

- Grade 304 stainless steel
- Maintenance free, guaranteed for 25 years
- Allows the door to swing in either direction
- Medium duty for internal doors weighing up to 80kg when floor mounted and up to 1100mm wide
- Top and bottom door plates have HI-LOAD maintenance free oil impregnated bronze bearings
- Set includes door bottom pivot bracket, top centre, door mounting plates and M5 x 30mm screws
- For adjustable unit see H131-450

Note: Door plates radii R12.5 for easier preparation

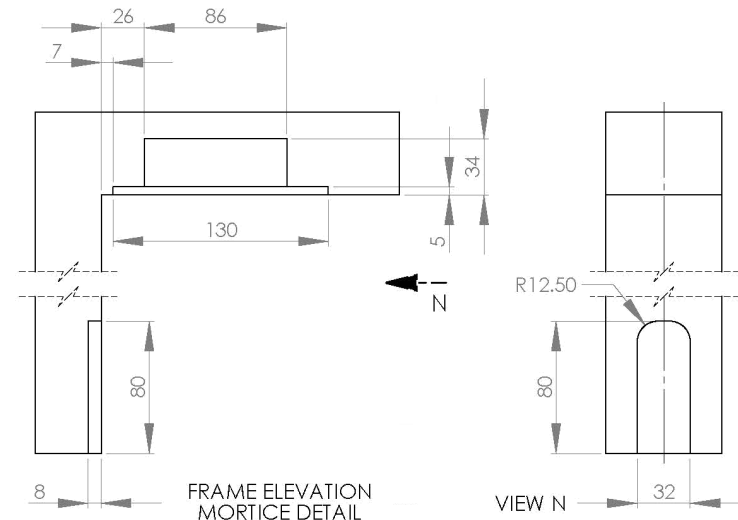
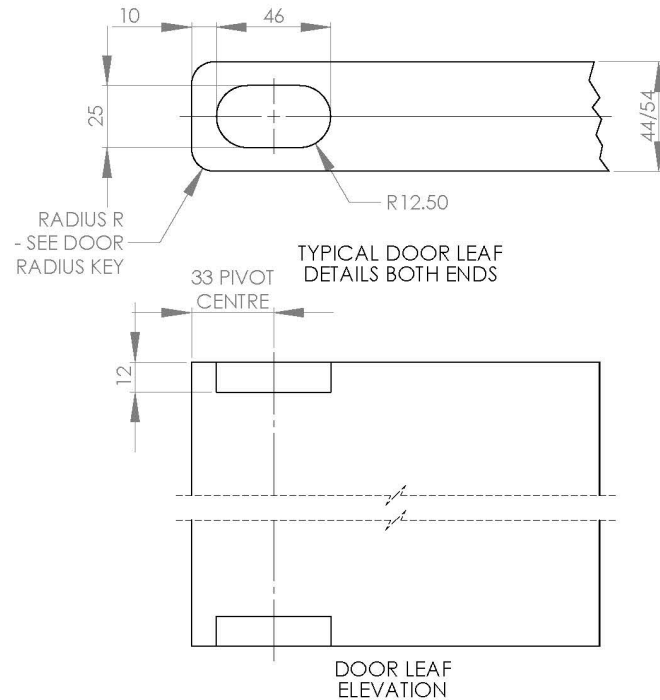
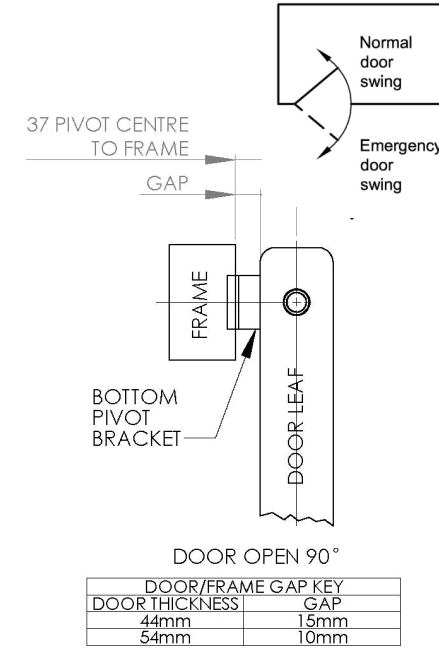
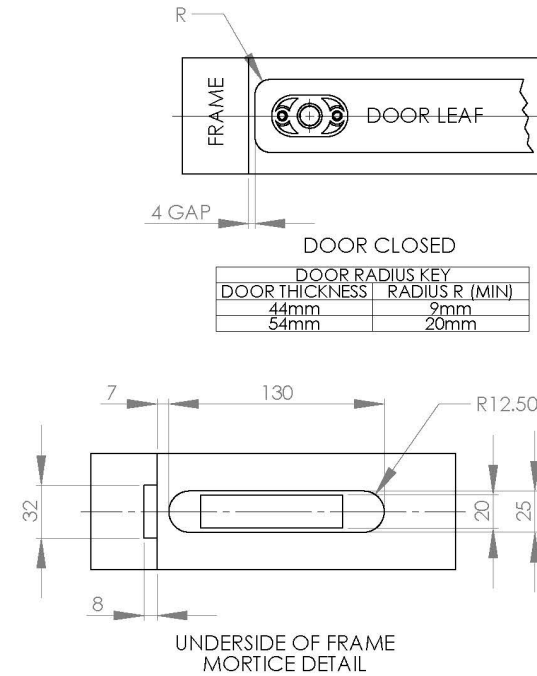
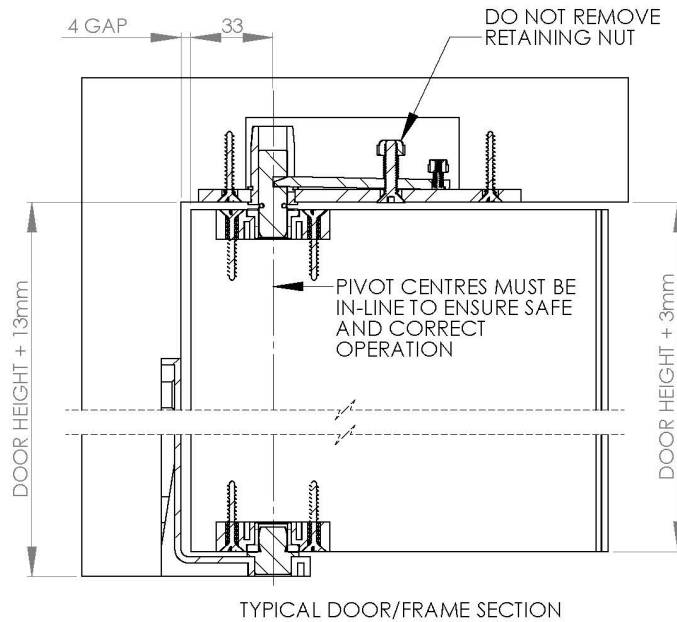

Royde & Tucker H131-400 HI-LOAD pivot set - FR Application

- Grade 304 stainless steel
- Maintenance free, guaranteed for 25 years
- Suitable for FD30 (44mm) and FD60 (54mm) doors, to BS 476 for both single and double door applications
- Allows the door to swing in either direction
- Medium duty for internal doors weighing up to 80kg when floor mounted and up to 1100mm wide
- Top and bottom door plates have HI-LOAD maintenance free oil impregnated bronze bearings
- Set includes door bottom pivot, top centre, door brackets and M5 x 30mm screws
- Intumescent pad pack HP131

Note: Door plates radii R12.5 for easier preparation

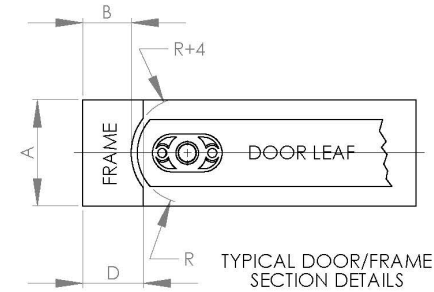
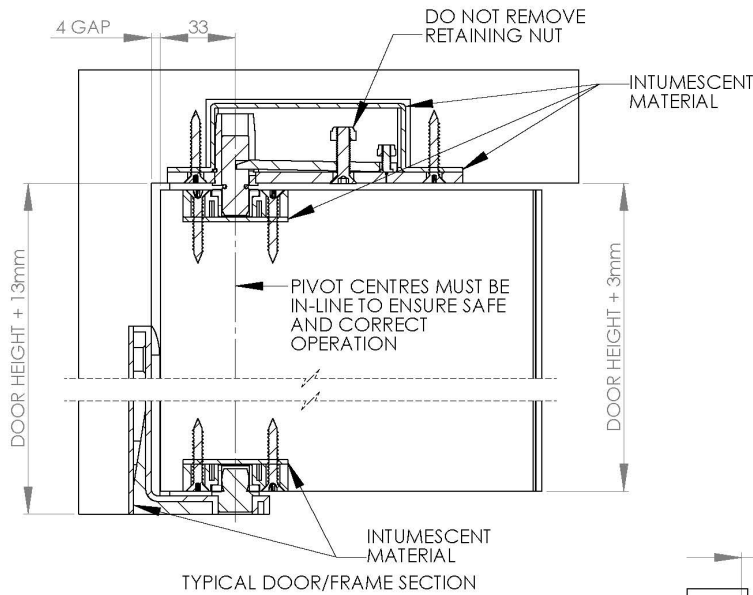

SCALLOPED FRAME DETAIL KEY	
A =	MINIMUM 70mm
B =	MINIMUM 22mm FOR HARDWOOD, 28mm FOR SOFTWOOD
D =	MINIMUM 30mm FOR HARDWOOD, 36mm FOR SOFTWOOD
R =	RADIUS FROM DOOR PIVOT

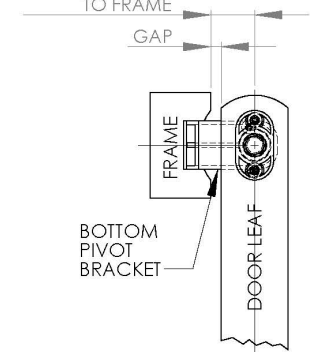
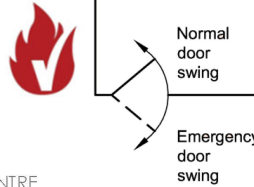

DOOR OPEN 90°

DOOR/FRAME GAP KEY	
DOOR THICKNESS	GAP
44mm	7mm
54mm	2mm

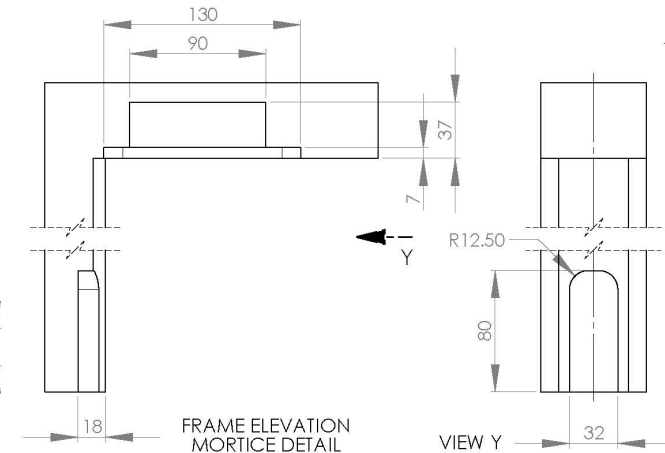
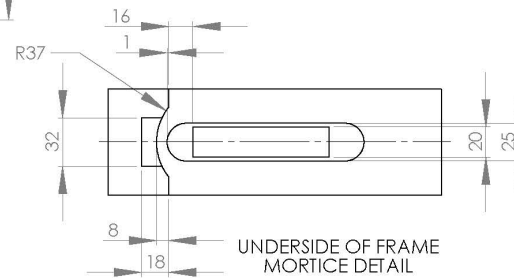
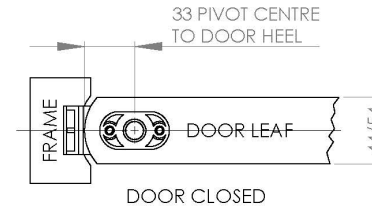
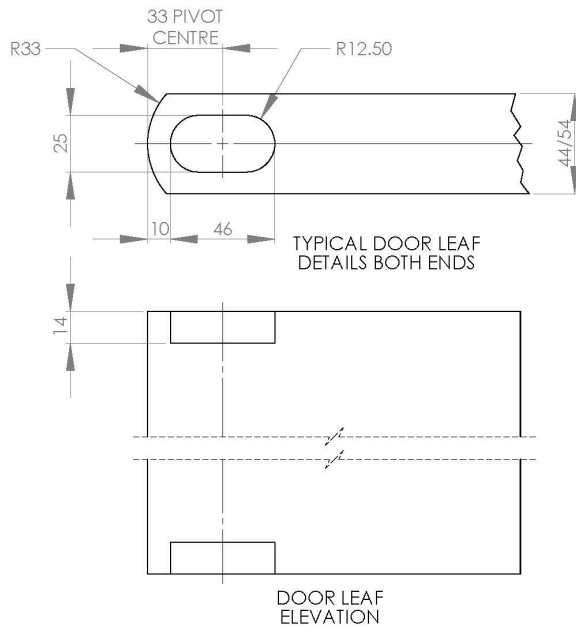

Royde & Tucker H131-402 HI-LOAD pivot set - NFR Application

- Grade 304 stainless steel
- Allows the door to swing in either direction
- Maintenance free, guaranteed for 25 years
- Bottom bracket is floor mounted and doesn't protrude beyond the doors face
- Medium duty for internal doors weighing up to 80kg and up to 1100mm wide
- Top and bottom door plates have HI-LOAD maintenance free oil impregnated bronze bearings
- Set includes door bottom pivot, top centre, door brackets and M5 x 30mm screws
- For adjustable unit see H131-452
- Note: Door plates radiused R12.5 for easier preparation

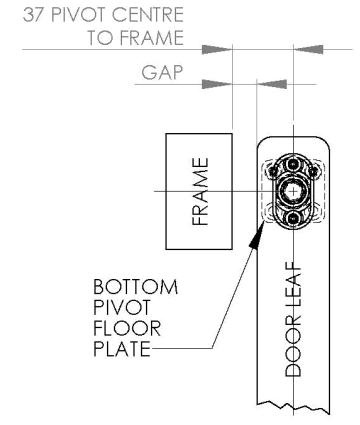
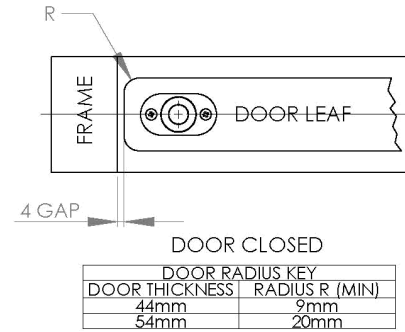
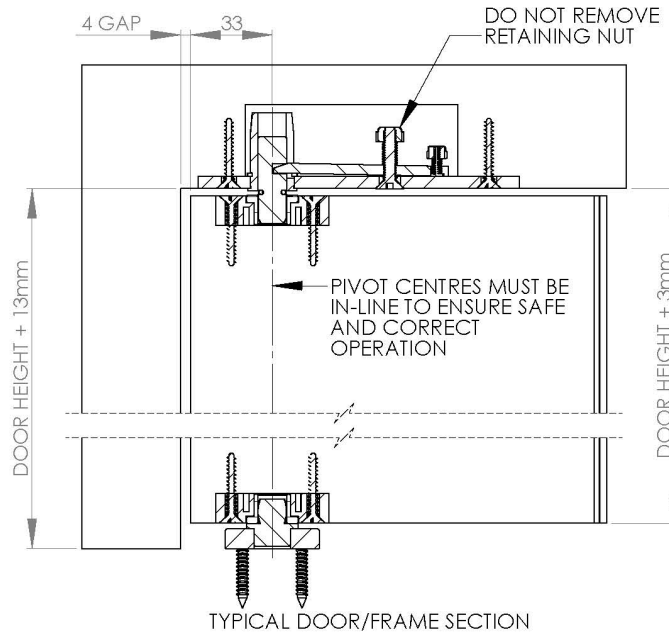

DOOR/FRAME GAP KEY	
DOOR THICKNESS	GAP
44mm	15mm
54mm	10mm

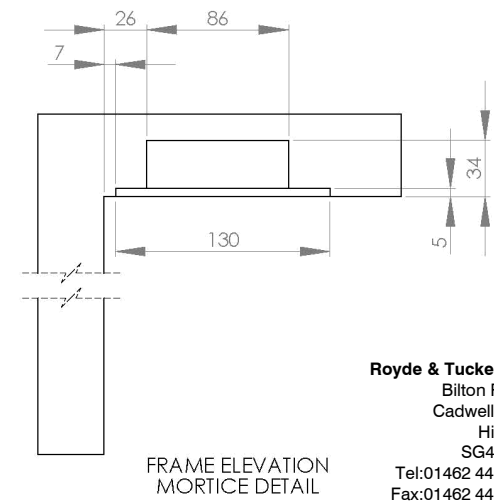
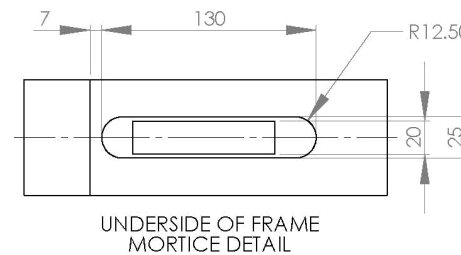
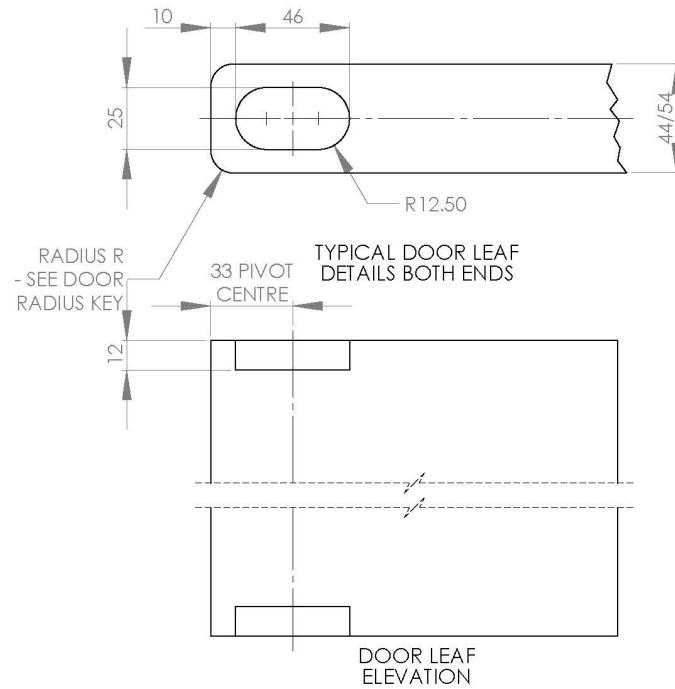

Royde & Tucker H131-402 HI-LOAD pivot set - FR Application

- Grade 304 stainless steel
- Suitable for FD30 (44mm) and FD60 (54mm) doors, to BS 476 for both single and double door applications
- Allows the door to swing in either direction
- Maintenance free, guaranteed for 25 years
- Bottom bracket is floor mounted and doesn't protrude beyond the doors face
- Medium duty for internal doors weighing up to 80kg and up to 1100mm wide
- Top and bottom door plates have HI-LOAD maintenance free oil impregnated bronze bearings
- Set includes door bottom pivot, top centre, door brackets and M5 x 30mm screws
- Intumescent pad pack HP131
- Note: Door plates radiused R12.5 for easier preparation

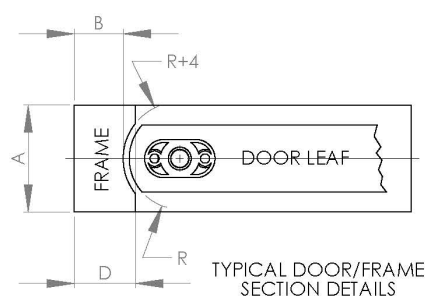
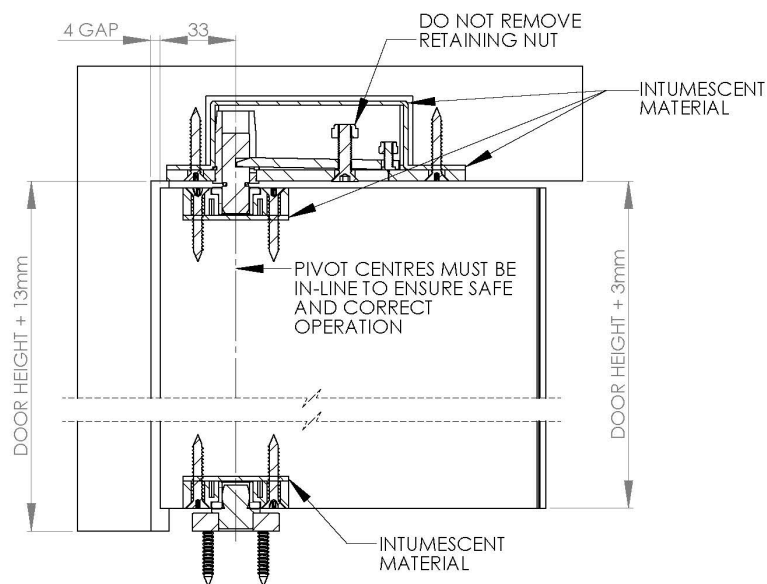

SCALLOPED FRAME DETAIL KEY	
A =	MINIMUM 70mm
B =	MINIMUM 22mm FOR HARDWOOD, 28mm FOR SOFTWOOD
D =	MINIMUM 30mm FOR HARDWOOD, 36mm FOR SOFTWOOD
R =	RADIUS FROM DOOR PIVOT

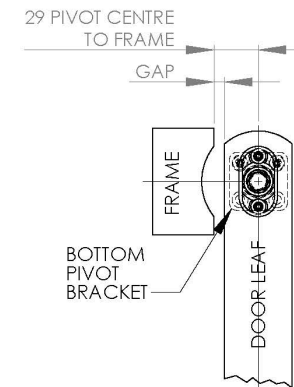
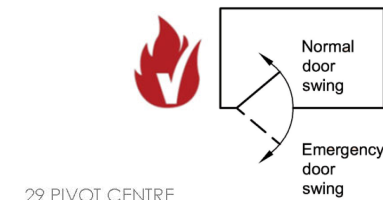

DOOR OPEN 90°

DOOR/FRAME GAP KEY	
DOOR THICKNESS	GAP
44mm	7mm
54mm	2mm

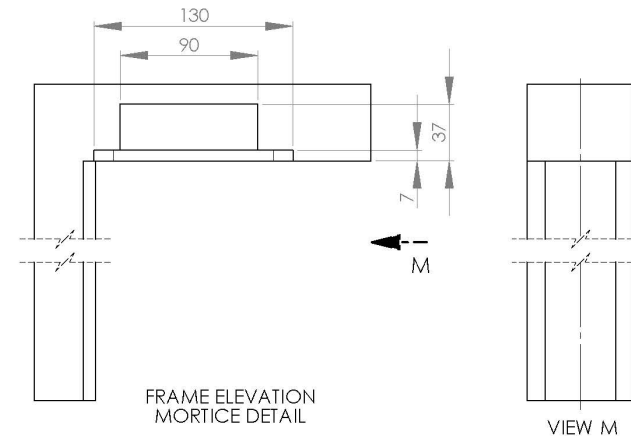
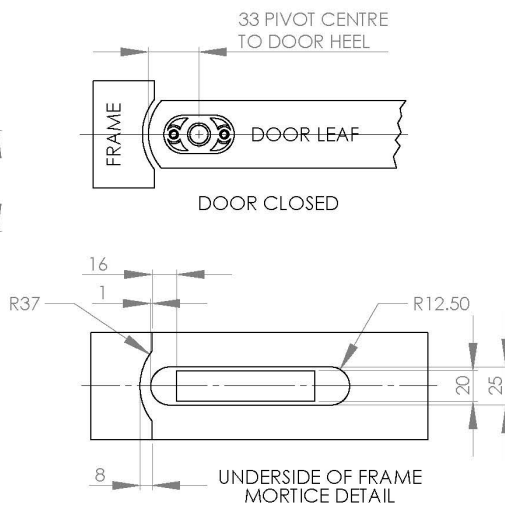
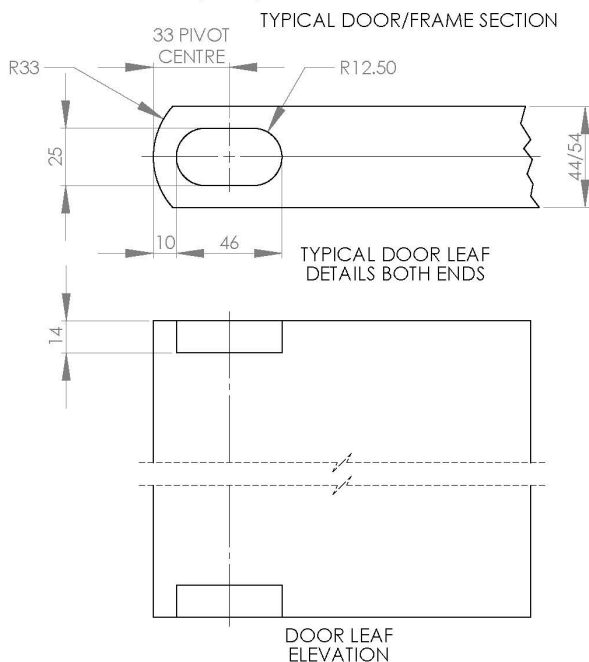

Royde & Tucker H131-401 HI-LOAD pivot set - NFR Application

- Grade 304 stainless steel
- Allows the door to swing in either direction
- Maintenance free, guaranteed for 25 years
- Bottom bracket is floor mounted
- Heavy duty for internal doors weighing up to 120kg and up to 1100mm wide
- Top and bottom door plates have HI-LOAD maintenance free oil impregnated bronze bearings
- Set includes door bottom pivot, top centre, door brackets and M5 x 30mm screws
- For adjustable unit see H131-451
- Note: Door plates radiused R12.5 for easier preparation

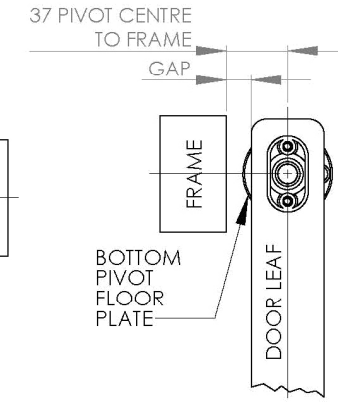
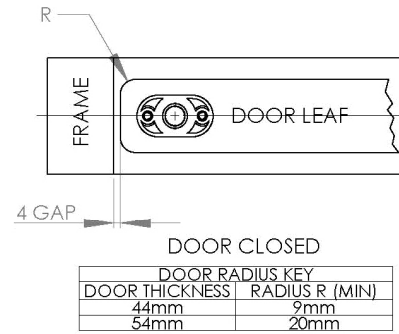
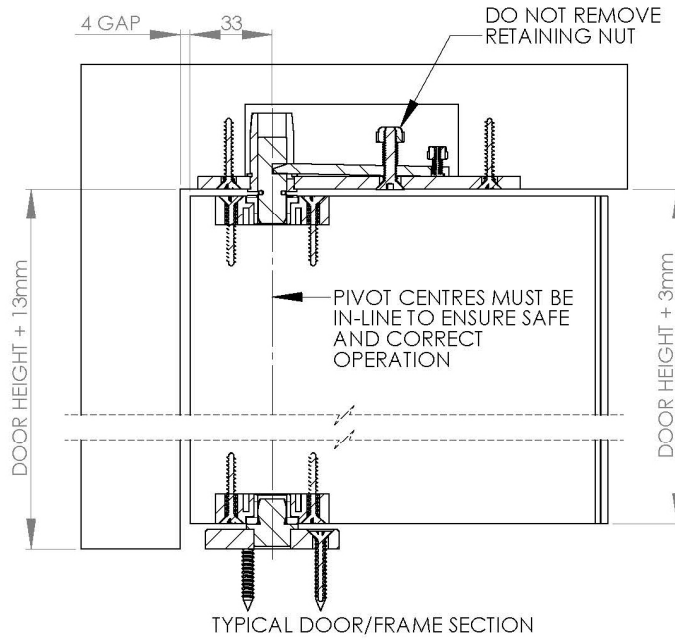

DOOR/FRAME GAP KEY	
DOOR THICKNESS	GAP
44mm	1.5mm
54mm	10mm

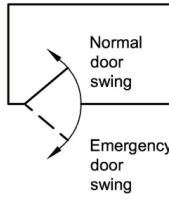
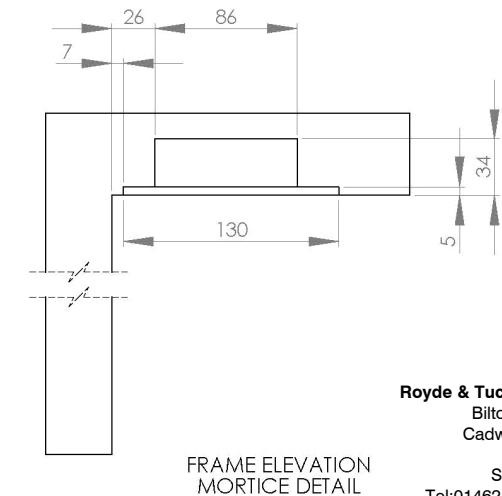
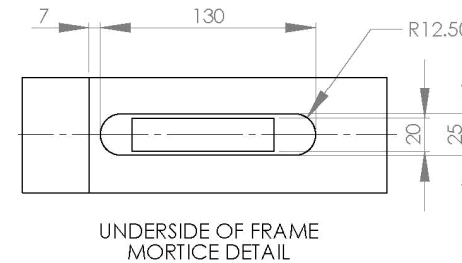
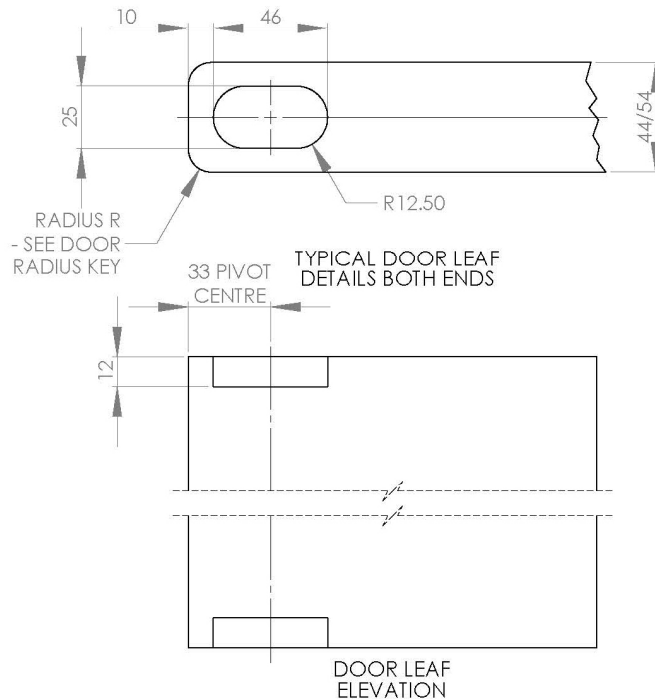

Royde & Tucker H131-401 HI-LOAD pivot set - FR Application

- Grade 304 stainless steel
- Suitable for FD30 (44mm) and FD60 (54mm) doors, to BS 476 for both single and double door applications
- Allows the door to swing in either direction
- Maintenance free, guaranteed for 25 years
- Bottom bracket is floor mounted and doesn't protrude beyond the doors face
- Medium duty for internal doors weighing up to 120kg and up to 1100mm wide
- Top and bottom door plates have HI-LOAD maintenance free oil impregnated bronze bearings
- Set includes door bottom pivot, top centre, door brackets and M5 x 30mm screws
- Intumescent pad pack HP131
- Note: Door plates radiused R12.5 for easier preparation

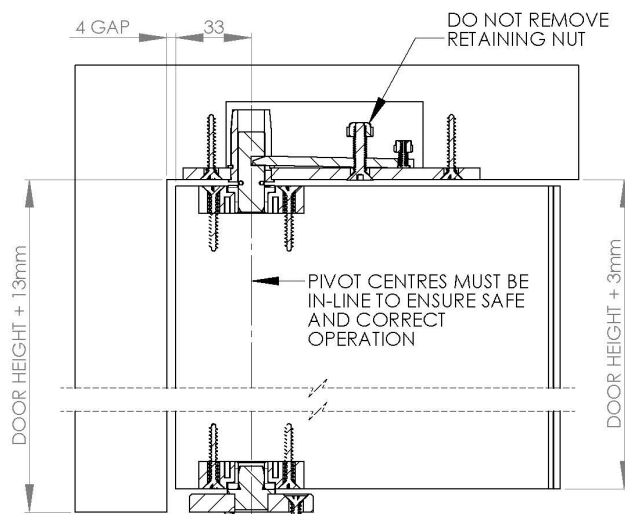

TYPICAL DOOR/FRAME SECTION

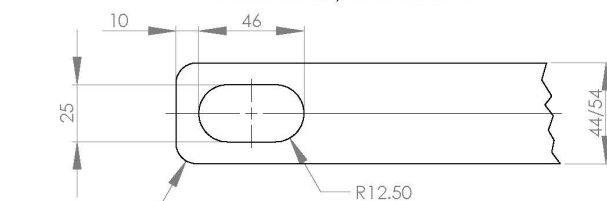

TYPICAL DOOR LEAF DETAILS BOTH ENDS

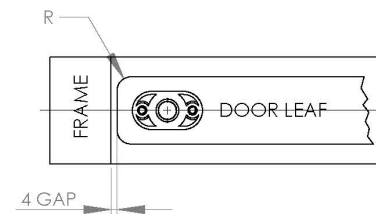
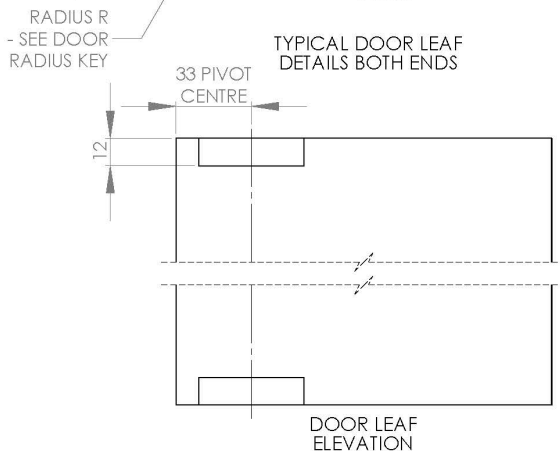

DOOR RADIUS KEY	
DOOR THICKNESS	RADIUS R (MIN)
44mm	9mm
54mm	20mm

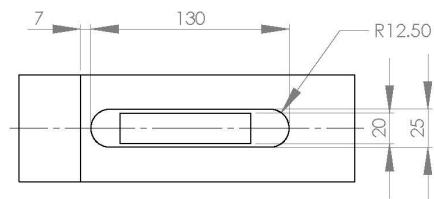

UNDERSIDE OF FRAME MORTISE DETAIL

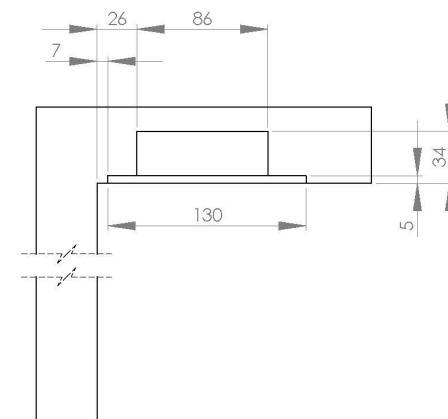

FRAME ELEVATION MORTISE DETAIL

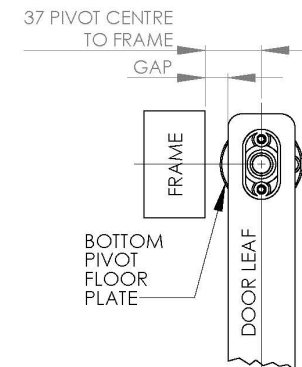
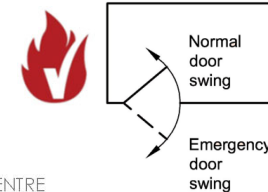

DOOR OPEN 90°

DOOR/FRAME GAP KEY	
DOOR THICKNESS	GAP
44mm	15mm
54mm	10mm

Royde & Tucker H131-100 HI-LOAD pivot set - NFR Application

- Grade 304 stainless steel
- Maintenance free, guaranteed for 25 years
- Allows the door to swing in either direction
- Medium duty for internal doors weighing up to 80kg when floor mounted and up to 1100mm wide
- Top and bottom door plates have HI-LOAD maintenance free oil impregnated bronze bearings
- Set includes door bottom pivot bracket, top centre, door mounting plates and M5 x 30mm screws

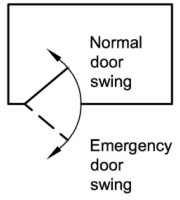
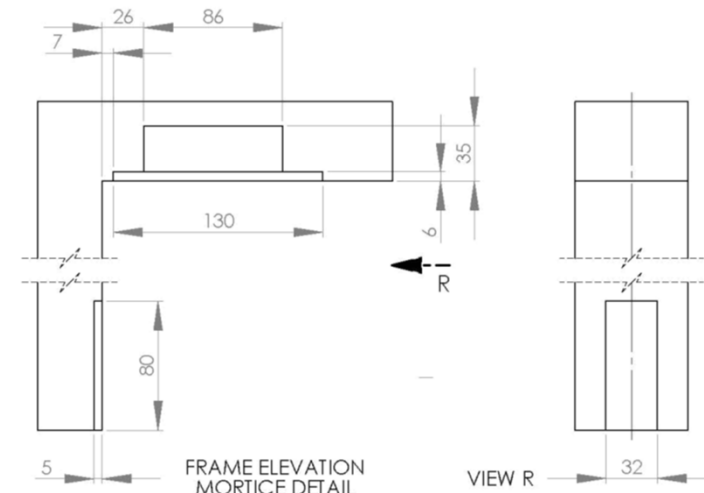
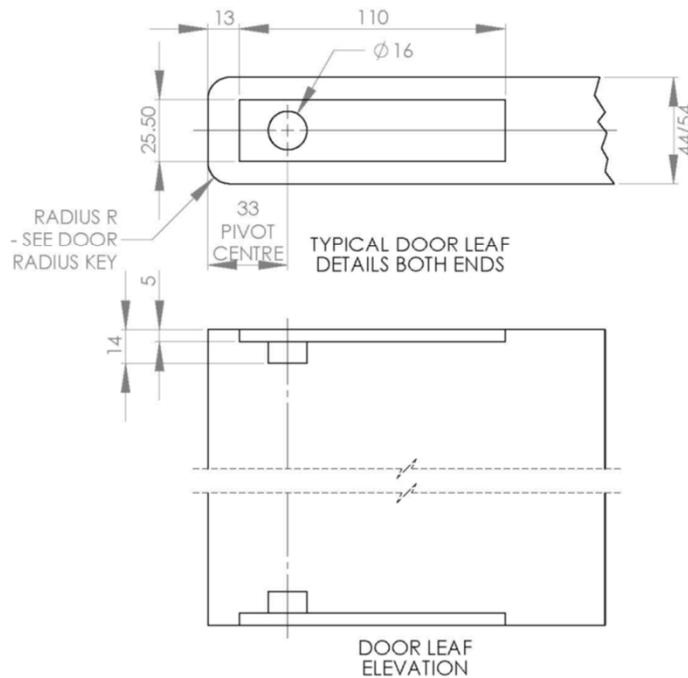
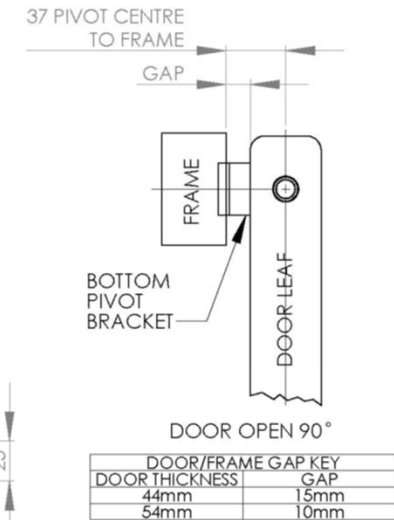
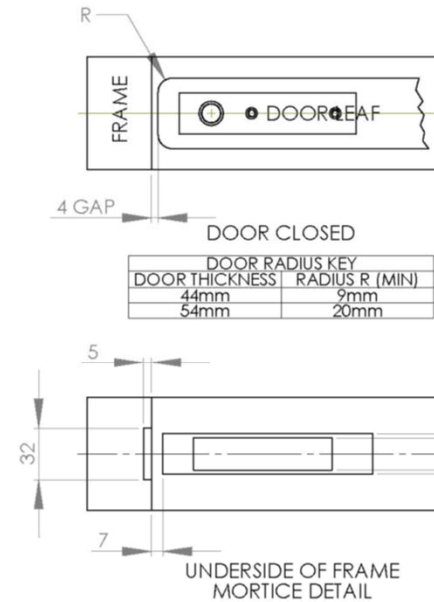
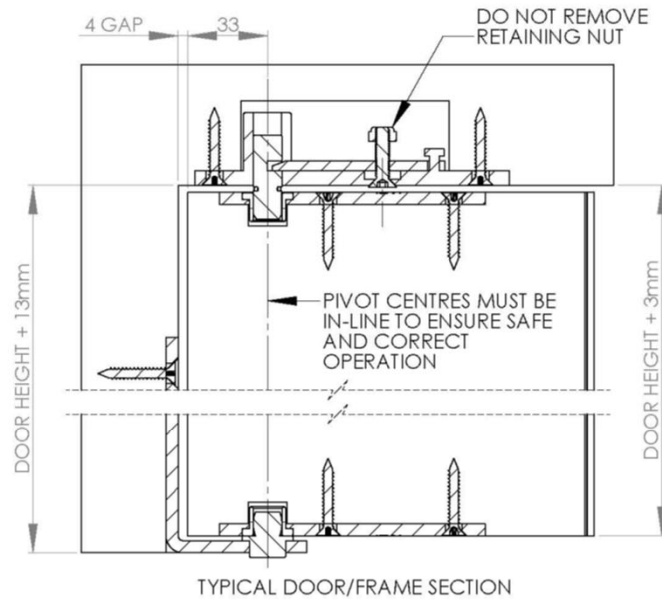

Royde & Tucker H131-100 HI-LOAD pivot set - FR Application

- Grade 304 stainless steel
- Maintenance free, guaranteed for 25 years
- Suitable for FD30 (44mm) and FD60 (54mm) doors, to BS 476 for both single and double door applications
- Allows the door to swing in either direction
- Medium duty for internal doors weighing up to 80kg when floor mounted and up to 1100mm wide
- Top and bottom door plates have HI-LOAD maintenance free oil impregnated bronze bearings
- Set includes door bottom pivot, top centre, door brackets and M5 x 30mm screws
- Intumescent pad pack HP131-100

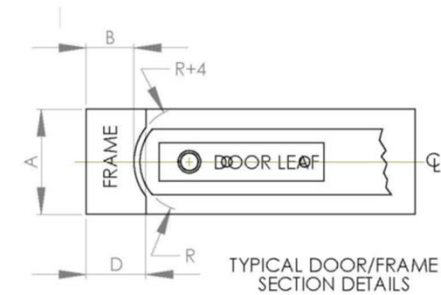
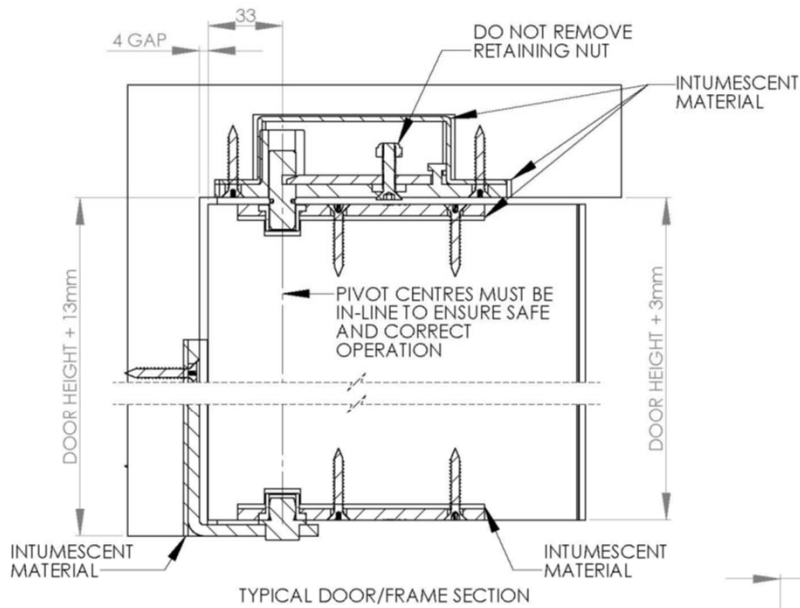

TYPICAL DOOR/FRAME SECTION DETAILS

SCALLOPED FRAME DETAIL KEY	
A =	MINIMUM 70mm
B =	MINIMUM 22mm FOR HARDWOOD, 28mm FOR SOFTWOOD
D =	MINIMUM 30mm FOR HARDWOOD, 36mm FOR SOFTWOOD
R =	RADIUS FROM DOOR PIVOT

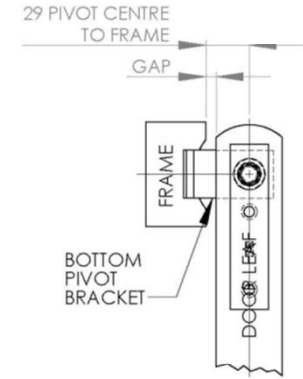
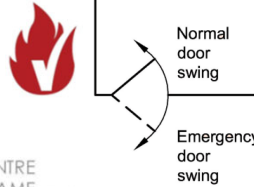

DOOR OPEN 90°

DOOR/FRAME GAP KEY	
DOOR THICKNESS	GAP
44mm	7mm
54mm	2mm

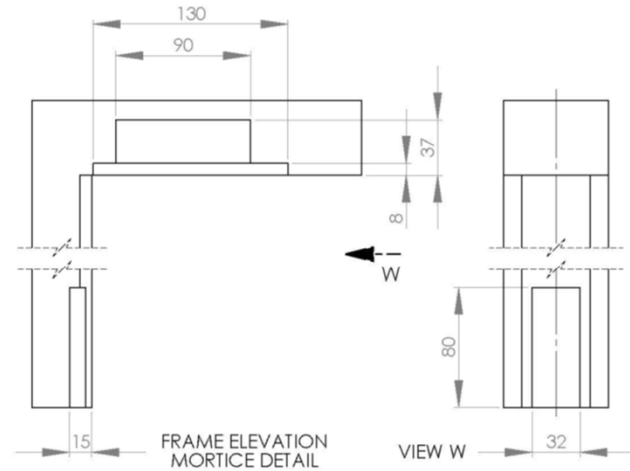
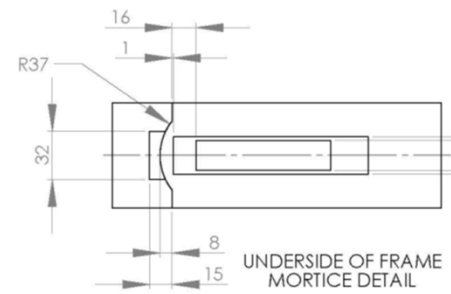
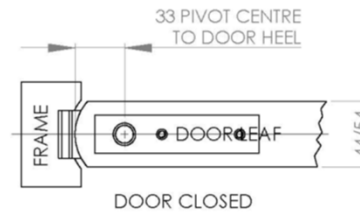
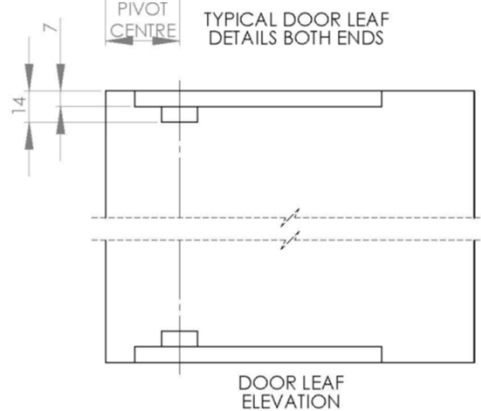
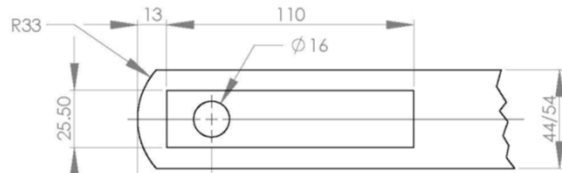

Royde & Tucker H131-450 HI-LOAD pivot set

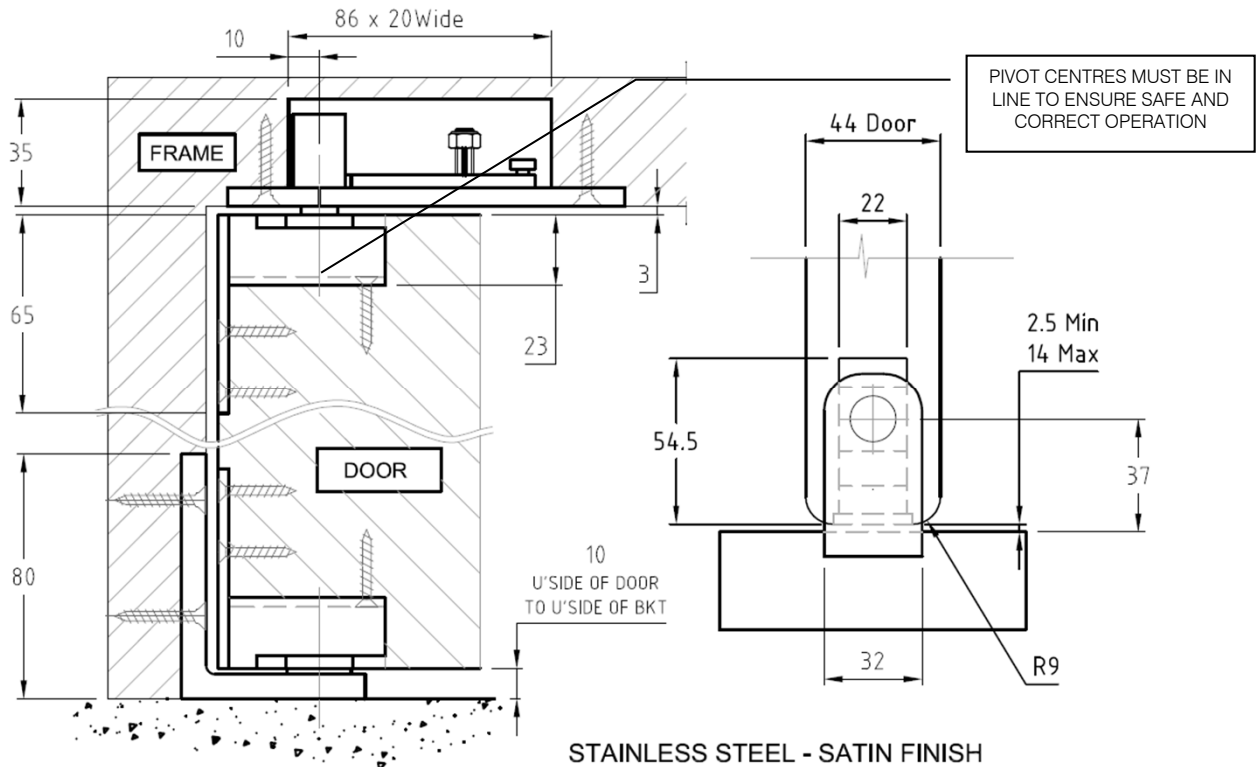
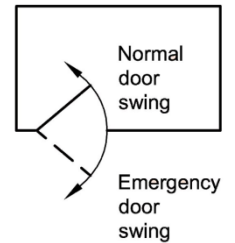

- Grade 304 stainless steel
- Maintenance free, guaranteed for 25 years
- Allows the door to swing in either direction
- Inclusive of adjustable top and bottom brackets (+/-5.5mm)
- For 44mm thick doors an R9 radius is required on the pivot edge
- For 54mm thick doors an R15 radius is required on the pivot edge
- Bottom bracket is frame mounted
- Medium duty for internal doors weighing up to 80kg and up to 1100mm wide
- Top and bottom door plates have HI-LOAD maintenance free oil impregnated bronze bearings
- Set includes door bottom pivot, top centre, door brackets and screws

Royde & Tucker Ltd
Bilton Road
Cadwell lane
Hitchin
SG4 0SB
Tel:01462 444444
Fax:01462 444433
www.ratman.co.uk
e-mail: sales@ratman.co.uk

Royde & Tucker H131-451 HI-LOAD pivot set

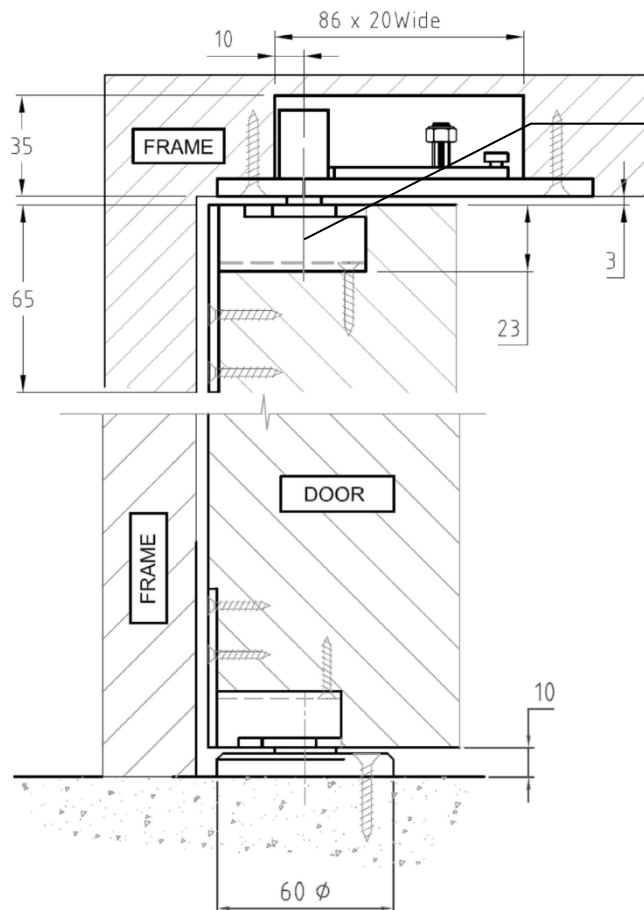
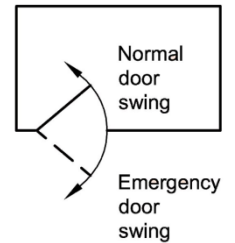

- Grade 304 stainless steel
- Maintenance free, guaranteed for 25 years
- Allows the door to swing in either direction
- Inclusive of adjustable top and bottom brackets (+/-5.5mm)
- For 44mm thick doors an R9 radius is required on the pivot edge
- For 54mm thick doors an R15 radius is required on the pivot edge
- Bottom bracket is floor mounted
- Medium duty for internal doors weighing up to 120kg and up to 1100mm wide
- Top and bottom door plates have HI-LOAD maintenance free oil impregnated bronze bearings
- Set includes door bottom pivot, top centre, door brackets and screws

Royde & Tucker Ltd
Bilton Road
Cadwell lane
Hitchin
SG4 0SB
Tel:01462 444444
Fax:01462 444433
www.ratman.co.uk
e-mail: sales@ratman.co.uk

Royde & Tucker H131-452 HI-LOAD pivot set

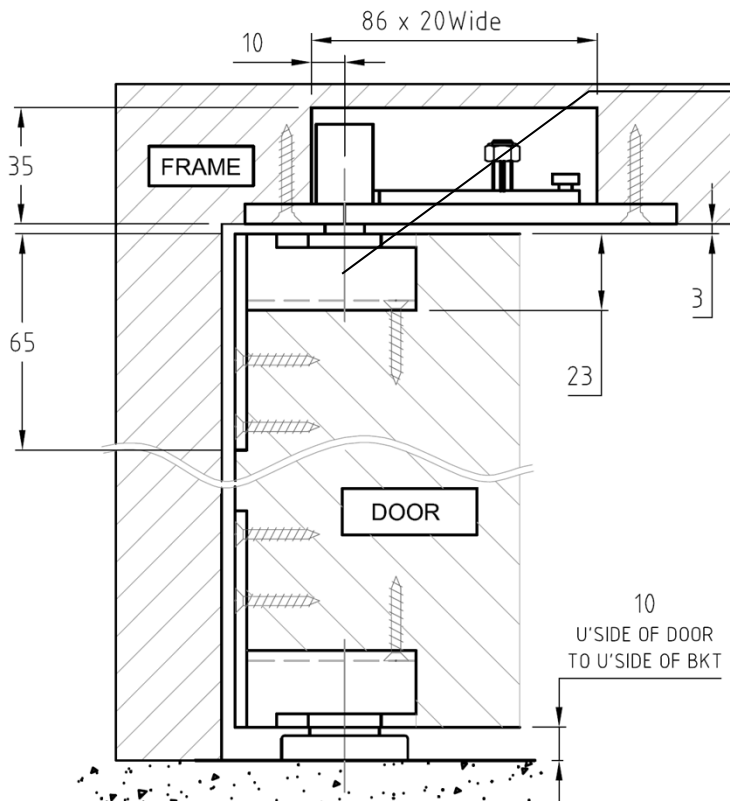
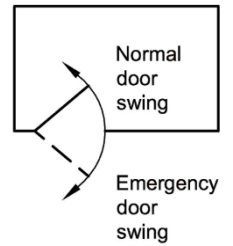

PIVOT CENTRES MUST BE IN LINE TO ENSURE SAFE AND CORRECT OPERATION

- Grade 304 stainless steel
- Maintenance free, guaranteed for 25 years
- Allows the door to swing in either direction
- Inclusive of adjustable top and bottom brackets (+/-5.5mm)
- For 44mm thick doors an R9 radius is required on the pivot edge
- For 54mm thick doors an R15 radius is required on the pivot edge
- Bottom bracket is frame mounted
- Medium duty for internal doors weighing up to 80kg and up to 1100mm wide
- Top and bottom door plates have HI-LOAD maintenance free oil impregnated bronze bearings
- Set includes door bottom pivot, top centre, door brackets and M5 x 30mm screws

Royde & Tucker Ltd
Bilton Road
Cadwell lane
Hitchin
SG4 0SB
Tel:01462 444444
Fax:01462 444433
www.ratman.co.uk
e-mail: sales@ratman.co.uk