

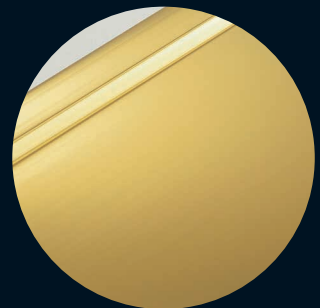

CI/SfB  
(31.59) X

# Fire/Smoke & Acoustic Letterplate System

Issue **Five**

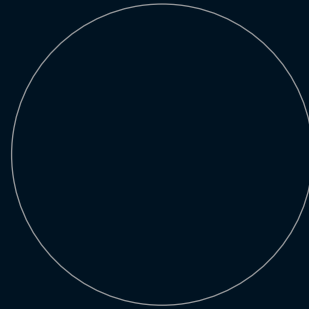

# R&T Letterplate systems

The Royde & Tucker letterplate system is unique in terms of product quality, flexibility, security, finishes and the testing standards to which it subscribes. It can be installed as a refit item or into new doorsets. The LP008 version is the 3<sup>rd</sup> party UKAS accredited tested system approved for use under the latest Building Regulations, Approved Document Q, having passed TS008:2015.

## Approved Document Q

Approved documents are guidance for the requirements of building regulations. Building regulations need to be complied with for all new buildings and changes to existing buildings which fall within the scope of the building regulations. Compliance to the building regulations will start from the planning stage of a new building or change of use of a building.

Document Q is the latest addition to Building Regulations and brings security to the forefront by setting out reasonable standards for doors and windows in all new residences/dwellings. Under the new standards, all new doors and windows should be made to a design that has been shown, by testing, to meet the security requirements of PAS24:2012 (or other standards that meet or exceed PAS24:2012).

From 1<sup>st</sup> October 2016 all letterplates fitted to doors which give access to the dwelling will be required to have been part of a PAS24 security test or meet the requirements of TS008. TS008 is a Door and hardware federation (DHF) technical specification for the security of letterplates.

## PAS 24

A PAS is a Publicly Available Specification. Generally if a British Standard (BS) or Euro Norm (EN) standard does not exist for a specific product then a PAS can be developed with the assistance of the BSI and produce what is effectively an industry "standard". The contents of the PAS are put together and then BSI circulates it to its own relevant technical panels and to relevant industry people, such as trade associations etc, for comment and adjustment. The result is a set of generally accepted standards against which both product testing and independent assessment can be evaluated.

It is important to note that PAS 24 is for a doorset. A component such as a letterplate, cannot be considered to be a PAS 24 product, as PAS 24 only applies to the full doorset. A PAS 24 doorset is considered to be a relatively secure assembly and each of the components fitted together correctly perform as part of the wider doorset assembly.

## What's covered by PAS 24?

For Doors the below situations are covered:

- The entrance(s) to a building
- Garages where there is a connecting door to the dwelling
- For flats and apartments. Main entrance doors to individual dwellings and any doors that open onto communal areas

## What's required?

- Door sets must meet PAS24:2016, OR
- Products must meet other standards which give comparable security performance to PAS24:2016

## TS008: 2015

### **Enhanced security and general requirements for letter plate assemblies and slide through boxes**

TS008: 2015, as above, is the DHF Technical Specification for letterplates. As letterplates in themselves cannot be tested to PAS24 then TS008:2015 is the latest test method for letterplate security.

The document provides a classification for the enhanced security and general requirements for letter plate assemblies and slide through boxes. This technical specification provides a means of evaluation against opportunist attack, fishing and lock manipulation. Additionally, attempts may be made to try and prevent the contents being removed and assess the product against potential arson attack.

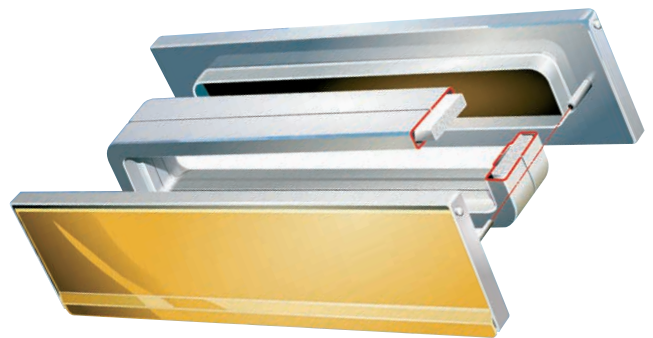

# LP series



## Standard letterplate systems

- System includes fire/smoke resistant models for FD30S and FD60S doors
- Appropriate for installation where fire risk may be from either side of the door
- Suitable for use on acoustic doorsets. Achieves 31Db/R<sub>w</sub> sound reduction on an appropriate door
- Certifire Approved – CF255
- LP 01,02,03 passed fixings/flap rip off test to 120kg/100kg
- LP 04,05,06 passed fixings rip off test to 120kg
- To suit door thicknesses:  
42–47mm, 47–52mm, 52–57mm
- Supplied complete with external and internal flap and aperture liner
- Flaps held in the closed position on magnets
- Easy to install, either at works or on site

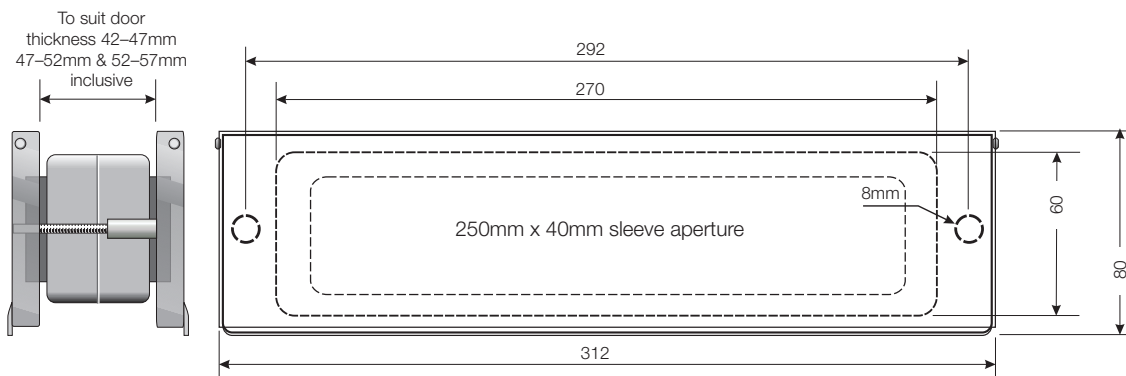

### PARTS

#### Aluminium letterflaps and Aluminum Frames

LP04-44: Non-Fire rated for 42–47mm Doors

LP04-49: Non-Fire rated for 47–52mm Doors

LP04-54: Non-Fire rated for 52–57mm Doors

LP05-44: 30 Minute Fire rated 42–47mm Doors

LP05-49: 30 Minute Fire rated 47–52mm Doors

LP05-54: 30 Minute Fire rated 52–57mm Doors

LP06-44: 30 Minute Fire rated inc Smoke seals 42–47mm \*

LP06-49: 30 Minute Fire rated inc Smoke seals 47–52mm \*

LP06-54: 30 Minute Fire rated inc Smoke seals 52–57mm

**Finishes:** Satin Anodised Aluminium – SAA, Gold Anodised Aluminium – GAA

\* Denotes Acoustic version available.

Please add suffix “A” to normal product code e.g. LP03-54-BSS-A.

Please note: Acoustic models are assembled to order.

#### Mild Steel/Stainless Steel frames and flaps

LP01-44: Non-Fire rated for 42–47mm Doors

LP01-49: Non-Fire rated for 47–52mm Doors

LP01-54: Non-Fire rated for 52–57mm Doors

LP02-44: 60 Minute Fire rated 42–47mm Doors

LP02-49: 60 Minute Fire rated 47–52mm Doors

LP02-54: 60 Minute Fire rated 52–57mm Doors

LP03-44: 60 Minute Fire rated inc Smoke seals 42–47mm Doors \*

LP03-49: 60 Minute Fire rated inc Smoke seals 47–52mm Doors \*

LP03-54: 60 Minute Fire rated inc Smoke seals 52–57mm Doors \*

**Finishes\*:** Brushed Stainless Steel – BSS, Polished Stainless Steel – PSS, Polished Brass Lacquered – PBL, Imitation Bronze – RBZ, Antique Brass – ABR, Dark Bronze – DBZ, Colour Powder Coated – NST

\* (For some finishes the frame is a different finish to the flaps. Please contact the same office if in doubt).



# LP08 – Approved Document Q

## TS008:2015 approved letterplate & security cowl (complete kit)

### Classification

A	1	2	N	3	Y	1	0
---	---	---	---	---	---	---	---

- Supplied complete with external and internal flaps, aperture liner and security cowl
- System includes for fire/smoke resistant models FD30S and FD60S doors
- System included integral weather seals
- Appropriate for installation where fire risk may be from either side of the door
- Suitable for use on acoustic doorsets. Achieves 31Db/R $\omega$  sound reduction on an appropriate door
- Security Tested to TS008:2015
- To suit door thicknesses: 42–47mm, 47–52mm, 52–57mm and 70mm
- Flaps held in the closed position on magnets
- Easy to install, either at works or on site
- Suitable for use on timber and some UPVC doors, please contact the sales office for guidance

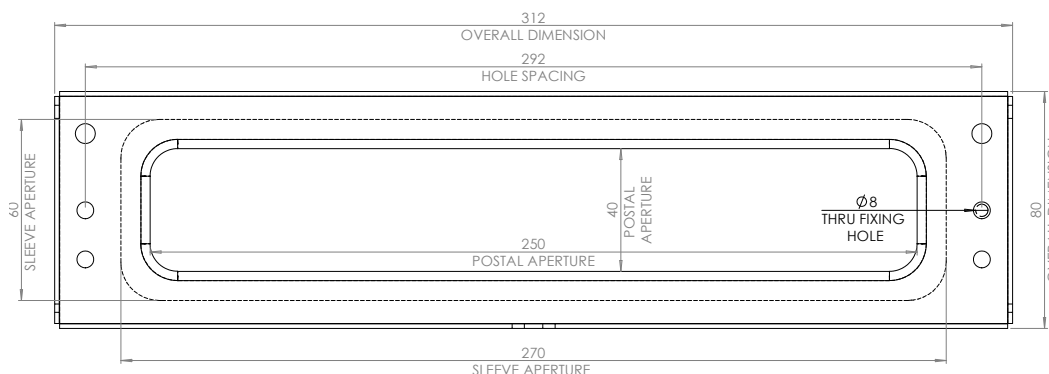
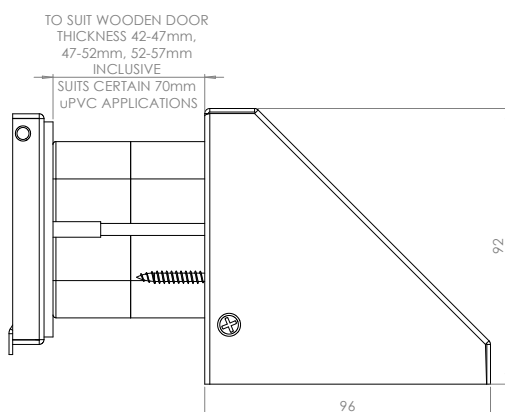

### PARTS

#### Mild Steel/Stainless Steel frames and flaps and cowl

- LP08-44: E30/E60 Fire rated inc Smoke seals 42–47mm Doors
- LP08-49: E30/E60 Fire rated inc Smoke seals 47–52mm Doors
- LP08-54: E30/E60 Fire rated inc Smoke seals 52–57mm Doors
- LP08-70: E30/E60 Fire rated inc Smoke seals 70mm Doors (suitable for some UPVC doors)

**Finishes\*:** Silver Anodised Finish – SAA,, Brushed Stainless Steel – BSS, Polished Stainless Steel – PSS, Polished Brass Lacquered – PBL, Imitation Bronze – RBZ, Antique Brass – ABR, Dark Bronze – DBZ, Colour Powder Coated – NST

\* (For some finishes the frame is a different finish to the flaps. Please contact the same office if in doubt).

### CLASSIFICATION

Classification of enhanced security and general requirements are detailed below –

#### 1<sup>st</sup> Digit: Product type

- A = Without any remotely fitted security hardware
- B = With remotely fitted security hardware p.7 of 22

#### 2<sup>nd</sup> Digit: Aperture type

- Type: 1 = Letterplate assemblies
- 2 = Slide through box

#### 3<sup>rd</sup> Digit: Enhanced security level

- 1 = Resistance to thumb-turn manipulation
- 2 = Resistance to thumb-turn manipulation and fishing

#### 4<sup>th</sup> Digit: Option to lock the letter plate to prevent delivery of mail

- N = No not lockable
- Y = Yes lockable

#### 5<sup>th</sup> Digit: Corrosion

- 3 = 96 hours
- 4 = 240 hours
- 5 = 480 hours

#### 6<sup>th</sup> Digit: Resistance to water penetration

- N = No performance determined
- Y = Pass

#### 7<sup>th</sup> Digit: Fire Resistance (to either BS476– 22 or EN 1634-1)

- 0 = No Fire resistance
- 1 = Yes

#### 8<sup>th</sup> Digit: Arson attack

- Grade 0 = No performance determined
- Grade 1 = Yes

# Optional accessories

(for use with standard LP01 to LP06 series letterplates)

## LP10

Internal security cowl. Obstructs view from outside, helps prevent manipulation of locks/bolts, tampering and attack from outside.

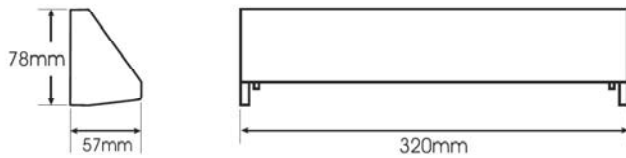

## LP11

Internal security latch. Secure inner flap in the "Closed" position.







**Royde & Tucker Ltd**

Bilton Road  
Cadwell Lane  
Hitchin  
SG4 0SB

Tel: 01462 444444  
Fax: 01462 444433  
[www.ratman.co.uk](http://www.ratman.co.uk)  
e-mail: [sales@ratman.co.uk](mailto:sales@ratman.co.uk)



[www.ratman.co.uk](http://www.ratman.co.uk)

©Royde & Tucker Ltd

Published 2016

Due to the progressive development,  
Royde & Tucker reserve the right  
to modify specifications and  
descriptions without prior notice.